



## **Underwater Housing for Sony Alpha A6300**

Product Number 6910.63

### **Product Registration**

Please register your product at [ikelite.com](http://ikelite.com) within 15 days of purchase. Our product registration database is the best way for us to get a hold of you in the event of a product update or recall.

## **About this Product**

Thank you for your purchase of Ikelite equipment. Please read this instruction manual completely before attempting to operate or dive with this product. Please visit [ikelite.com](http://ikelite.com) to register your product to receive information on any updates, notices, or recalls pertaining to your equipment.

## **Included in the Box**

- Housing
- Waterproof bulkhead cap
- Silicone lubricant
- Control + push button tip assortment

## **Important Notices**

- » **This housing requires a compatible Lens Port for waterproof operation. The housing is not waterproof without a Lens Port attached.**
- » **To prevent salt build-up and sticking controls, submerge the empty housing in clean, freshwater. Operate the controls several times each while underwater to flush out any residue.**
- » **Never leave a housing in a rinse tank, even if it is the only system in the tank. Most catastrophic floods happen when the user walks away from a housing while it is in the rinse tank.**
- » **Do not use alcohol, cleaning agents, spray lubricants, Rain-X, or other solvents on the housing or lens port. Use of an incompatible chemical compound can damage the plastic and o-rings, and may result in leaking.**

# Contents

<b>Product Registration</b> .....	<b>1</b>
<b>About this Product</b> .....	<b>2</b>
<b>Included in the Box</b> .....	<b>2</b>
<b>Important Notices</b> .....	<b>3</b>
<b>Getting to Know Your Housing</b> .....	<b>5</b>
<b>Setting Up Your Camera</b> .....	<b>7</b>
Pre-Installation Checklist.....	7
<b>Setting Up Your Housing</b> .....	<b>7</b>
Opening the Housing.....	7
Inserting the Camera.....	8
Attaching the Hotshoe.....	9
Closing the Housing.....	9
Attaching the Lens Port.....	10
Final Check.....	11
Entering the Water.....	11
<b>Setting Up An External Strobe</b> .....	<b>13</b>
About the Built-In Flash.....	13
About Sync Cords.....	13
Attaching a Sync Cord.....	13
About Fiber Optic Cords.....	14
Attaching a Fiber Optic Cord.....	15
<b>Maintenance</b> .....	<b>15</b>
Post-Dive.....	15
Travel and Storage.....	16
<b>Troubleshooting</b> .....	<b>16</b>
<b>Limited Warranty</b> .....	<b>18</b>
<b>Service and Repairs</b> .....	<b>19</b>
<b>Contact Us</b> .....	<b>20</b>

# Getting to Know Your Housing

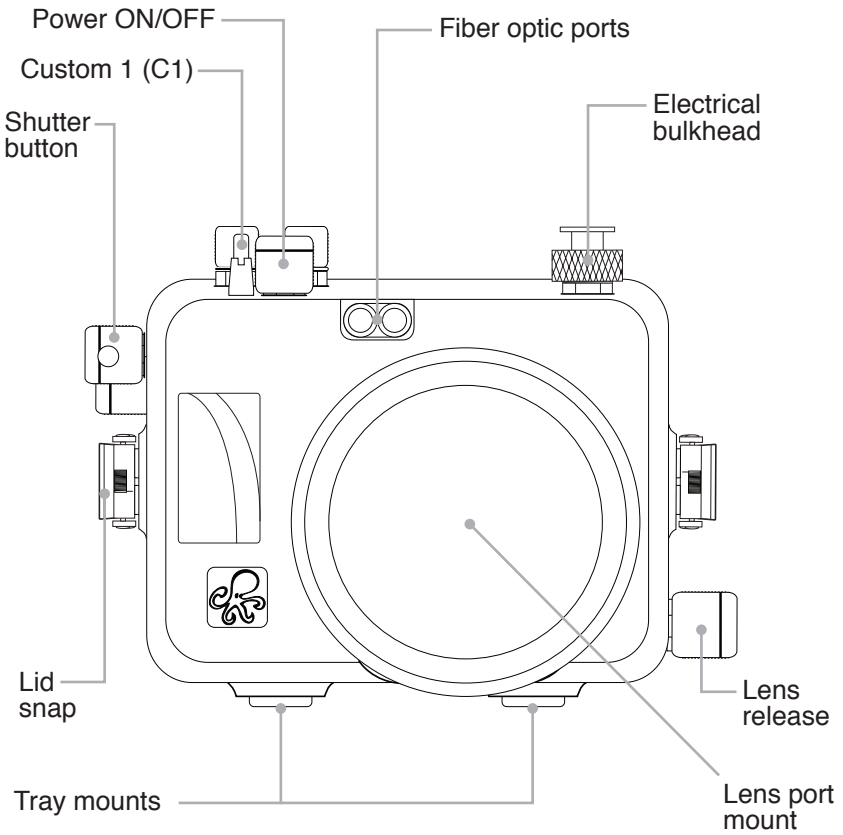

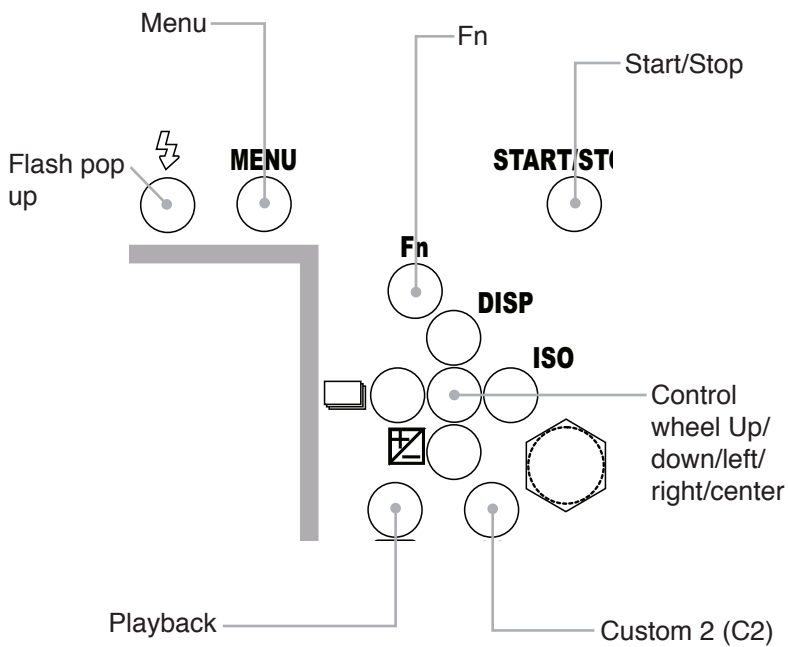
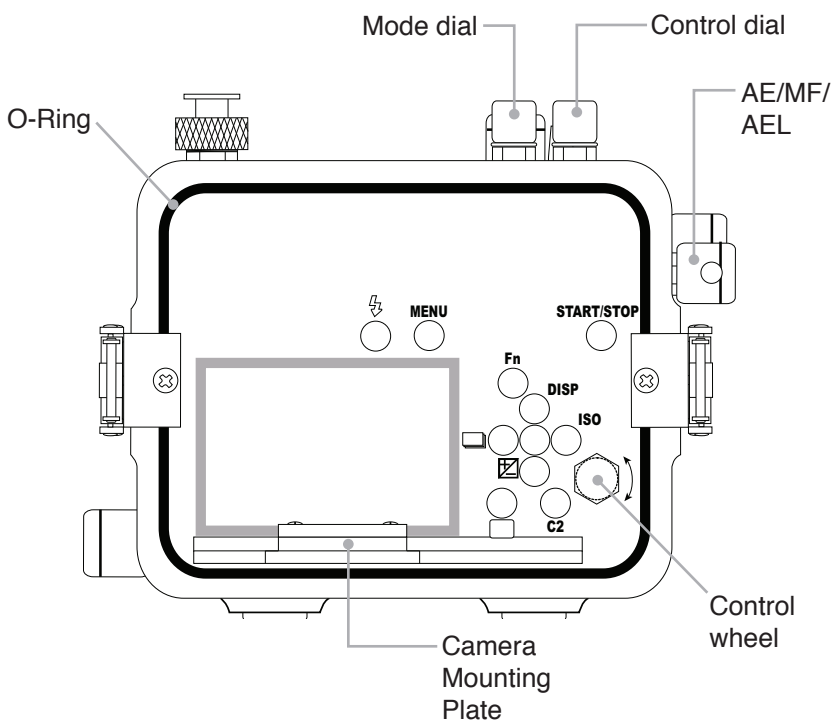

# Setting Up Your Camera

## Pre-Installation Checklist

1. Insert a fully charged camera battery.
2. Insert a properly formatted memory card.
3. Set Smile/Face Det. to OFF.
4. Set FINDER/MONITOR to Monitor.
5. Set ISO to ISO AUTO or a specific ISO setting. Do not use ISO AUTO Multi Frame NR setting if using a flash. This setting will prevent the flash from firing.

### ISO

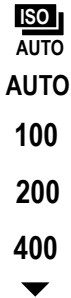

Multi Frame Noise Reduct.



# Setting Up Your Housing

## Opening the Housing

1. Push the lid snap lock forward and start to lift the curved end away from the housing.

2. Lid snaps are designed to provide enough force to compress the o-ring for a proper seal. Keep firm pressure against the lid snap while lifting it away.

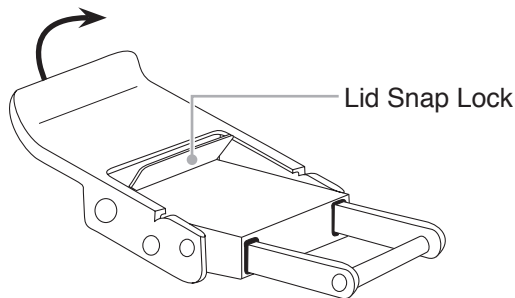

3. Repeat with remaining lid snaps.
4. Remove the housing back.

## Inserting the Camera

1. Remove any lanyard or neck strap which may be attached to the camera.
2. Check to see whether the camera's lens will fit through the port opening of the housing. If not, the lens will need to be removed from the camera body and re-attached AFTER the camera body is installed in the housing.
3. Remove the camera mounting plate from the housing.



4. Line the mounting screw up with the camera's tripod socket. Use a coin or flat head screwdriver to tighten the mounting plate to the camera.

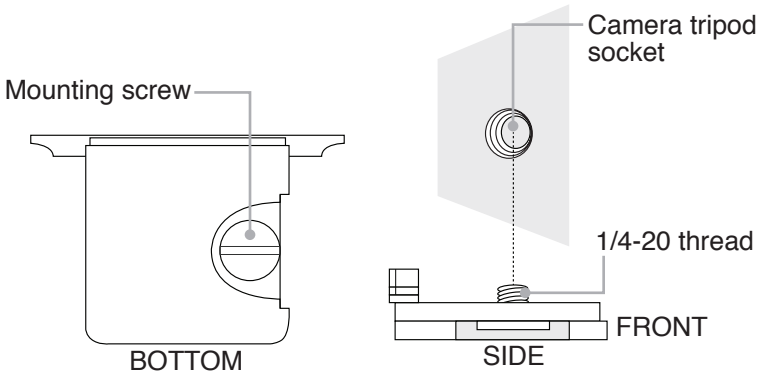

5. Pull out on the housing control knobs to move them out of the way.
6. Insert the mounting plate into the slot on the inside bottom of the housing. Push the camera all of the way forward until the back of the mounting plate is flush with the back of the housing mount.

## Attaching the Hotshoe

1. Make sure the contacts are clean.
2. Slide the hotshoe onto the camera with the LOCK marking towards the back of the camera.
3. Push the hotshoe forward until it is unable to go any farther. The hotshoe must be pushed all of the way forward to make proper contact with the camera and provide TTL operation.
4. Rotate the locking ring clockwise until snug.

## Closing the Housing

1. Make sure the o-ring is clean and in its proper location on the back of the housing. The main o-ring does not require lubricant to make a seal.

2. Place the back onto the housing front.
3. Make sure no controls or wires are interfering with the o-ring or the back of the housing.
4. Place each lid snap into the corresponding hook on the housing back.
5. Push the lid snaps towards the housing until they are flat against the housing and the lock has engaged. Close opposing lid snaps at the same time.
6. Check the o-ring seal. The o-ring should form a uniform, solid line around the back of the housing. There will be a small, even gap around the housing between the housing back and the housing front.

## Attaching the Lens Port

**A compatible lens port is required for waterproof operation.**

**Never submerge the housing without a lens port attached.**

1. Lightly lubricate the o-ring on the port base. When properly lubricated, the o-ring should have an even, slightly shiny appearance. Wipe off any excess lubricant. Lubricant prevents the o-ring from rolling or extruding; it is not a sealing mechanism.
2. If using a gear sleeve, place it on the port base with the teeth side outwards.
3. Slide the lens port onto the housing port base and press evenly down towards the housing until it stops. There should be a very thin, even gap between the bottom of the port and the housing front.
4. If using a dome with a shade, rotate the lens port gently so that the wider extensions are oriented on the top and bottom. If the shade is misaligned, it may cause vignetting (dark shadows in the corner of the image).

## Final Check

1. Re-check the o-ring seal. The seal should form an even, solid line around the back of the housing.
2. Turn on the camera and check all control functions.
3. Make sure that the camera can obtain focus and take a photo.
4. Check battery life and open storage space on your memory card.
5. Check the flash, if using.
6. Submerge the housing in a fresh water tank dedicated to underwater photography equipment. Visually confirm that there are no signs of water intrusion or a steady stream of bubbles coming from one of the housing's seals.

## Entering the Water

1. If possible, we recommend entering the water without your housing to ensure that you are comfortable and your life-saving equipment is in working order. Once you are stable, have someone pass your camera housing to you.
2. Before entering the water, turn the camera **ON** and operate each of the housing controls to get a feel for using the camera in the housing.
3. As soon as you enter the water, take a moment and check to see that the housing is properly sealed. Using your finger, wipe away any air bubbles on the face of the lens port. If possible, first water test the housing with no camera inside to assure a safe and watertight environment.

4. The **ON/OFF** camera knob has a White Dot. To turn camera **ON**, lift knob and rotate White Dot to the **10 o'clock** position from the back of the housing. Lower and then rotate knob slightly clockwise to turn camera **ON**. **DO NOT** continue rotating knob once camera is activated or you could damage the switch.

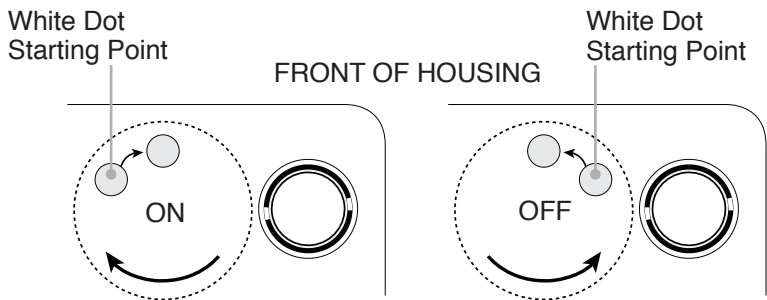

5. To turn camera **OFF**, lift knob and rotate White Dot to the **2 o'clock** position. Lower and rotate knob slightly counterclockwise until camera turns **OFF**. **DO NOT** continue rotating knob once camera is deactivated or you could damage the switch.
6. Submerge the housing at the surface of the water and visually confirm that there are no signs of water intrusion or a steady stream of bubbles coming from one of the housing's seals. If water does appear to be entering the housing, point the lens port downward and return the housing to the surface as quickly as possible. Please observe all necessary safety precautions. **NEVER** ascend faster than accepted safety limits.
7. Use your hand to gently flush away any small bubbles that may be on the face of the lens port. Bubbles will produce soft focus spots in your photo or video.

# Setting Up An External Strobe

## About the Built-In Flash

The lens port opening is enlarged to accept a variety of wide angle, zoom, and macro lenses. This larger lens port opening blocks a significant portion of the camera's built-in flash, making it unusable to light a subject underwater.

We recommend attaching an external strobe for the optimal color and clarity in a wide variety of shooting situations, including daylight photography. An external strobe may be triggered via electrical sync cord or fiber optic cord.

## About Sync Cords

Attaching a strobe via electrical sync cord provides faster strobe recycle times as compared to a fiber optic connection, and prolongs camera battery life.

When a compatible Ikelite DS strobe is attached via sync cord, circuitry built into the housing allows the strobe to communicate directly with the camera to trigger the strobe and adjust its power for perfect exposure.

Strobes from SEA&SEA, INON, and Nikonos attached by electrical sync cord are not capable of powering the TTL circuitry built into this housing. These strobes must be used in manual power modes when connected via electrical sync cord.

## Attaching a Sync Cord

**A bulkhead cap or sync cord must be attached to the housing for waterproof operation. Never submerge the housing without either a sync cord or waterproof bulkhead cap attached.**

1. Remove the bulkhead cap.

2. Lightly lubricate the sync cord o-rings. We recommend using only Ikelite silicone lubricant to eliminate the possibility of swelling due to incompatible compounds.
3. Line up the pins and receptacles and insert the sync cord plug into the bulkhead.

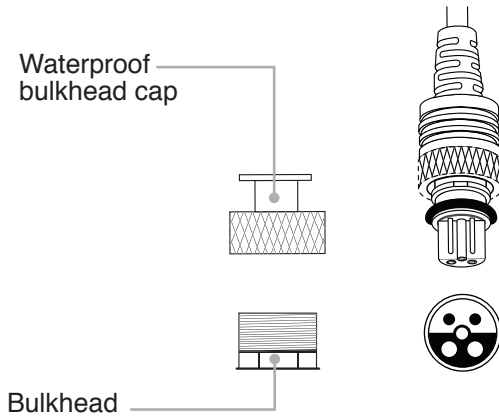

4. Rotate the knurled retaining ring until snug on the housing's bulkhead. Do not use pliers or tools to tighten the retaining ring.
5. Attach the other end(s) of the sync cord to the bulkhead(s) on your strobe(s).
6. If using an Ikelite strobe, set the strobe to TTL. If using a non-Ikelite strobe, set the strobe to manual flash and select a manual power setting.
7. Turn on the strobe(s).
8. Turn on the camera.
9. Take a test photo to ensure that your strobe(s) are functioning properly.

## About Fiber Optic Cords

Attaching a strobe via fiber optic connection requires the camera's built-in flash to fire each time a photo is taken. Firing the camera's flash will cause increased lag time in between photos and decrease camera battery life.

## Attaching a Fiber Optic Cord

1. Check the end of the fiber optic cord to ensure that it is clean and smooth.
2. Ensure that the fiber optic cord o-ring is in place. This o-ring does not provide waterproofing, however it does keep the fiber optic cord in place.
3. Attach one end of the fiber optic cord into one of the fiber optic ports on the front of the housing. The connector is a press-fit into the fiber optic port.
4. Attach the other end of the fiber optic cord to a compatible strobe.
5. Set the strobe to the appropriate setting based on manufacturer recommendations.
6. Turn the camera on and pop up the built-in flash.
7. Turn the strobe(s) on.
8. Take a test photo to ensure that your strobe(s) are functioning properly.

## Maintenance

### Post-Dive

1. Rinse the housing in fresh water. Rotate the housing's controls and press each button while submerged in fresh water to flush out any salt or debris to ensure smooth operation on future dives.

2. NEVER leave your housing in the fresh water rinse tank. Collisions with other peoples' gear can cause scratches or damage to your equipment.
3. Stow the housing in a shaded place where it is protected from impact or overheating. If no shade is available, we recommend covering the housing with a towel or cloth.
4. Check the memory card capacity and battery life of your camera and strobe(s). Recharge as necessary.
5. Always re-check o-ring seal after opening the housing.

## Travel and Storage

1. Remove the camera from the housing for travel or storage.
2. Check the main housing o-ring.
3. Close the empty housing and submerge in lukewarm fresh water. While submerged, rotate each control and depress each button to flush out any salt or debris.
4. Remove the housing from water and rinse with running water.
5. Do not rinse the inside of the housing or submerge the open housing in water. If the inside of the housing needs to be cleaned, wipe with a clean, slightly damp cloth.
6. Dry the housing with a clean, lint-free cloth.
7. Store in a cool, dry place.
8. Like regulators and other pressure-sensitive equipment, we recommend careful care and cleaning along with annual replacement of the factory seals.

## Troubleshooting

### Water enters the housing

- Re-clean and re-install the main o-ring.



- Take the housing underwater without a camera installed to ensure that the leaking has been corrected.

### **Photos are over-exposed (too light)**

- Adjust aperture (smaller), shutter speed (faster), or ISO (lower) setting.
- Move lights(s) farther away from your subject.
- Adjust exposure compensation in the camera.
- Adjust lighting power.

### **Photos are under-exposed (too dark)**

- Adjust aperture (larger), shutter speed (slower), or ISO (higher) setting.
- Move light(s) farther away from your subject.
- Adjust exposure compensation in the camera.
- Adjust lighting power.

### **Strobe will not fire**

- Turn on strobe.
- Make sure that the camera's flash is set to fire on every photo.
- Check that the fiber optic cord is attached.

### **Buttons are stuck**

- Soak the housing in lukewarm fresh water. Depress each button several times while the housing is submerged.
- Apply lubricant to the button. Press the button several times to distribute the lubricant.

### **Button(s) or control(s) do not line up**

- Ensure that nothing is preventing the camera from going into the housing.
- Push the camera mounting plate forward until it is flush with the housing base plate.

### **Camera is not functioning normally underwater**

- Ensure that the camera mounting plate is pushed all of the way into the housing mounting plate.
- Check each housing control while underwater to ensure that they are disengaged. An inadvertently engaged control may limit functioning of the camera.
- Check that the zoom control is returned to the center position.

### **Backscatter or “snow” in images**

- Position strobes or lights farther away from your lens and at a slight angle.
- Avoid using strobes in extremely low-visibility conditions.

## **Limited Warranty**

This Ikelite product is warranted against any manufacturing defects for a period of one (1) year from the original date of purchase. Defective products should be returned to Ikelite postage paid. Ikelite will, at its sole discretion, repair or replace such products, and will return to customer postage paid. All other claims of any nature are not covered. Except as mentioned above, no other warranty expressed or implied applies to this Ikelite product.

## **Service and Repairs**

Ikelite is most interested in performing any service to ensure that all products perform as intended. Evidence of purchase date must be provided to obtain warranty service. No prior authorization is required. You may return directly to us or through your dealer. Please include a brief description of the problem, any relevant email correspondence, and/or description of the service request. Always include name, shipping address, email address, and phone number inside of the package. Send postage paid to:

Ikelite Underwater Systems  
Attn: Service Department  
50 West 33rd Street  
Indianapolis, IN 46208 USA

For the separate international customs documentation form that you complete to accompany the shipment, please state or designate that the enclosed products were originally manufactured in the USA and are being returned to the manufacturer for repair service. Value of the equipment listed for customs purposes should be zero.

## Contact Us

If you have any questions about your product or need advice on getting the images you want, please get in touch with us and we'll do everything we can to help you capture your unique perspective.

Ikelite Underwater Systems  
50 W 33rd St  
Indianapolis, IN 46208 USA  
(317) 923-4523  
ikelite@ikelite.com